

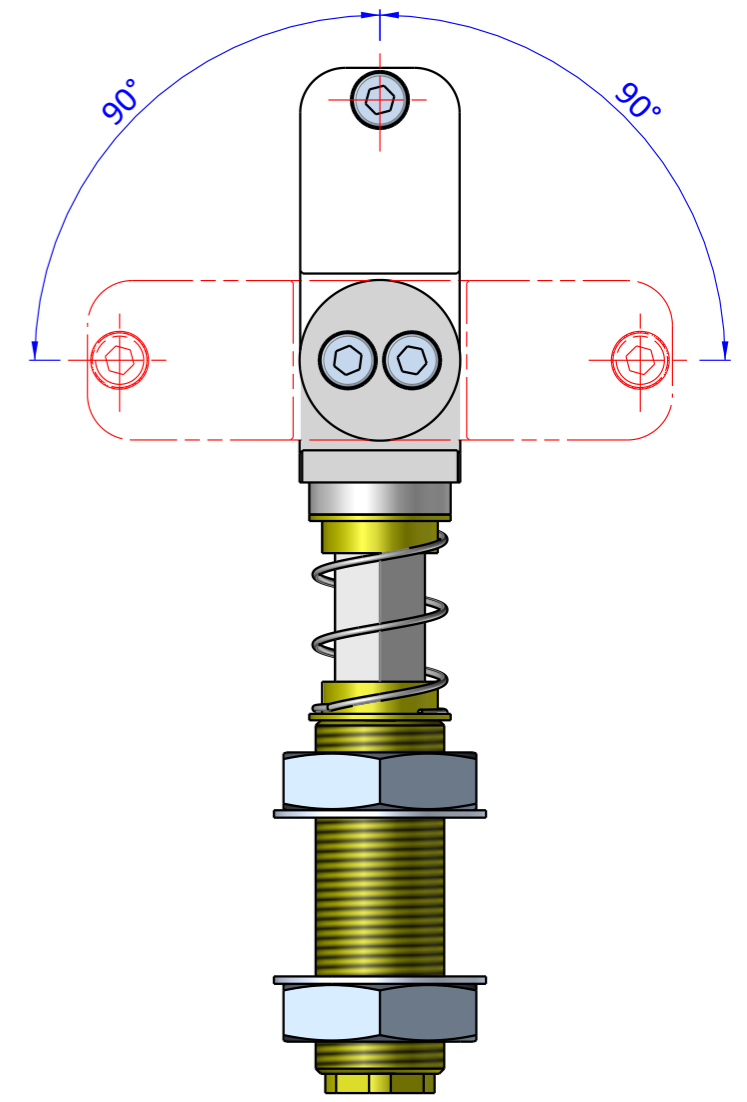

THE PROPERTY OF THE DRAWING IS ESTABLISHED BY LAW. IT IS FORBIDDEN TO PRODUCE OR SHOW IT TO THIRD PART. WITHOUT A WRITTEN AGREEMENT.

Item	Name	Q.ty
1	05.02.001.06	2
2	GVR.20.2	1
3	GVR.20.3	1
4	M.21x44	1
5	R.5.SCH	3
6	R.20.SCH	2
7	SAE.20141825.2	1
8	SAE.20141825.4	2
9	SAE.20141825.5	1
10	SAEG.20141825.3	1
11	SAM.2020.1	1
12	V.TCE5x25	3

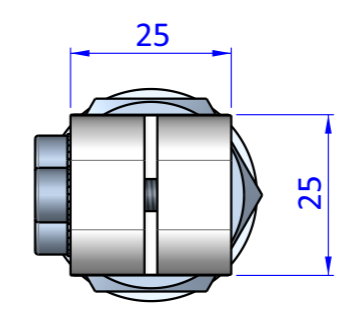
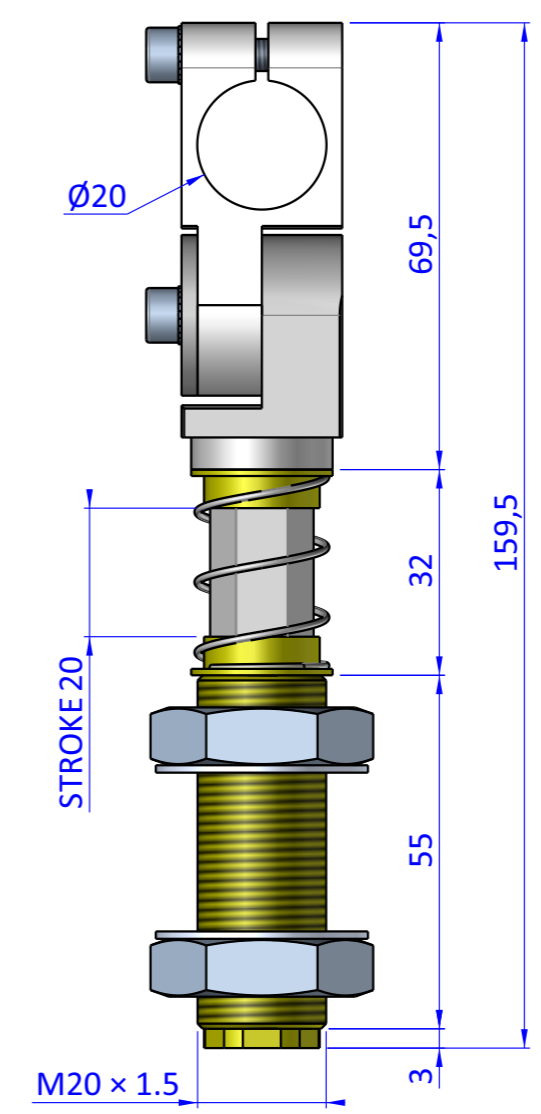
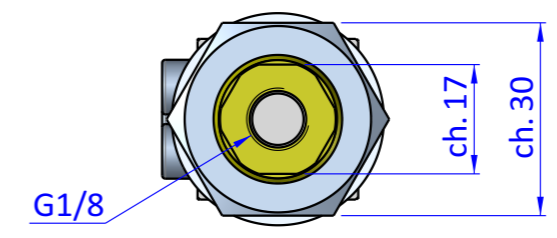
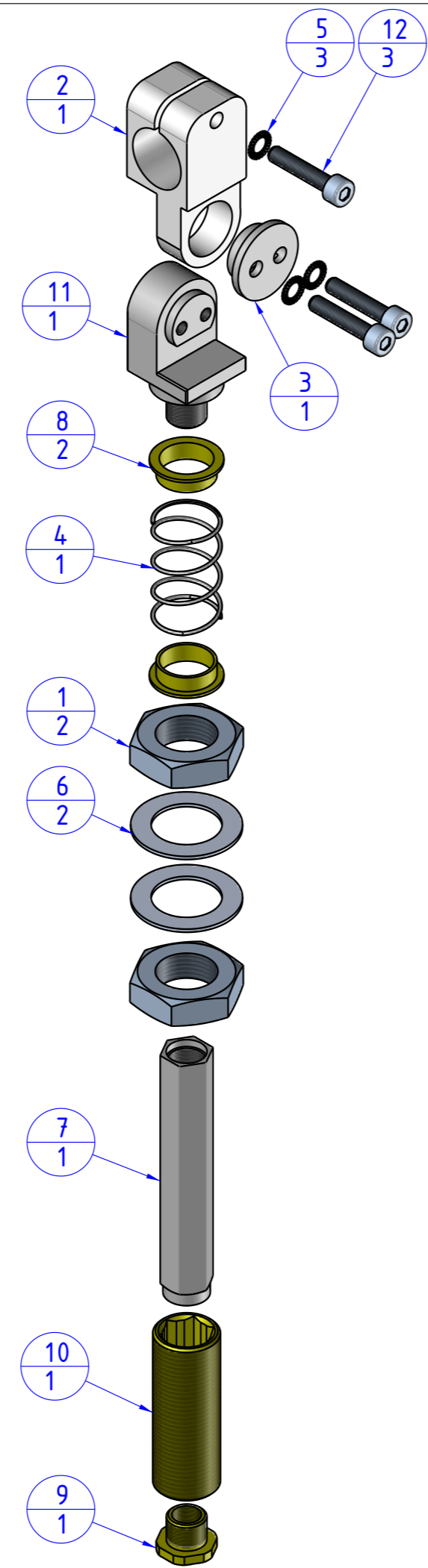

Format A3
UNI 936-76

 FPS FPSERVICES AUTOMATION		DESIGNED FROM		REVIEW
		FPS Automation		A
GENERAL TOLERANCE		DATE	WEIGHT	
UNI - ISO 2768		24/01/2022	0,201kg	
CLASSE f		DESCRIPTION	CODE	
		CA.SAMG.202520	CA.SAMG.202520	